

CONOTECH

Precision without compromise



NIGHT ARROW

Thermal Imaging Riflescope

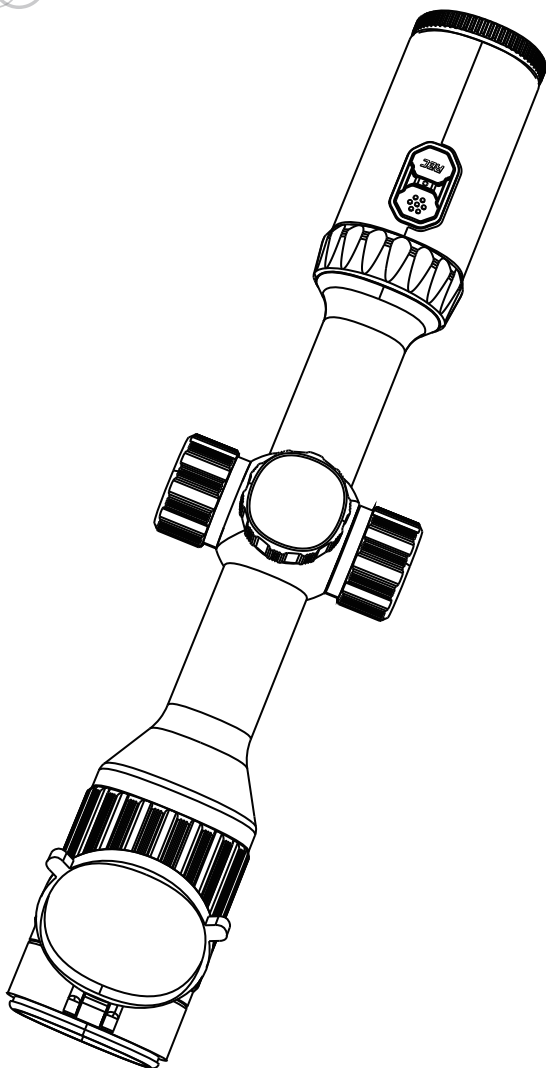

Attention!

Export of **Night Arrow Series** models may have export restrictions depending on the laws in your region.

RoHS  

Attention!



The proper usage of the device is important for safe exploitation! Therefore, reading carefully the present manual!



If the device was left in storage for a longer period of time, before exploitation check its functionality.



Disassembling of the device is prohibited, except in authorized repairing centers.



The external optical surfaces should be clean at all times. Touching the optical surfaces with bare hands is not recommended.



Sand and sea water can damage the optical coatings!



Do not point the device directly at the sun!



Image performance is dependent on scenery and atmosphere conditions. Contrast in the same image may vary as a function of the time of day due to the effect of the sun. For example, at sunset objects will have absorbed different levels of heat resulting in greater temperature differences and better contrast.



When left in storage for a longer period of time, batteries have to be removed and stored in polyethylene bags to prevent contact with metal. (It is recommended to recharge the batteries every two to three months)



When carrying or transporting the device, put the protective lens cap!



Condensation can cause fogging of the optical surfaces!
Condensation occurs when the temperature or humidity changes as follows:

- When moving the device from cold to warm place or vice versa
- In places with high humidity

When equalizing the temperature of the device with the environmental, the condensation disappears. Use the towel to remove moisture.



Clean the lens surfaces with the lens cloth or with the napkin!

LEGAL NOTICE

Before attaching to weapons, check the regional legal regulations in the area of application.
The attachment to a weapon is always the sole responsibility of the user.

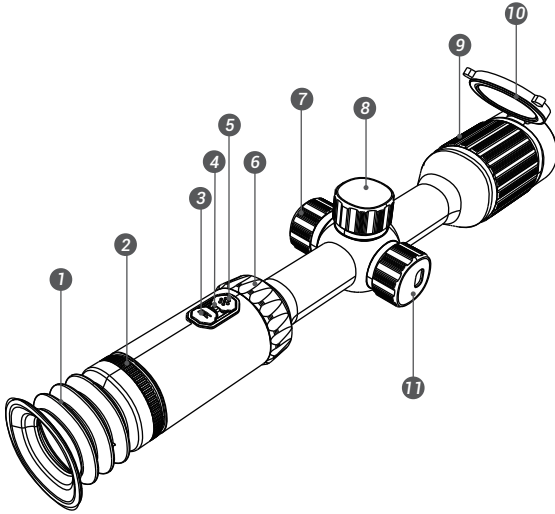

NOTE

All images used in this instruction manual are for illustrative purpose only. Actual product may vary due to product enhancement.(v.3.0)

- 1** Rubber eyepiece
- 2** Diopter adjustment ring
- 3** REC button
- 4** LED indicator
 - 🔴 Charging: Red light flashes
 - 🟢 Full power: Green light is steady on
 - 🔴 Low power: Red light is steady on
 - 🟢 Wifi on: Green light flashes quickly
 - 🟢 Wifi connects successful: Green light turns on for 3s and turns off
 - 🟢 USB connects: Green light flashes
- 5** MENU button
- 6** Rotating wheel
- 7** Battery compartment cap
- 8** Controller
- 9** Focus ring
- 10** Lens cover
- 11** USB-C

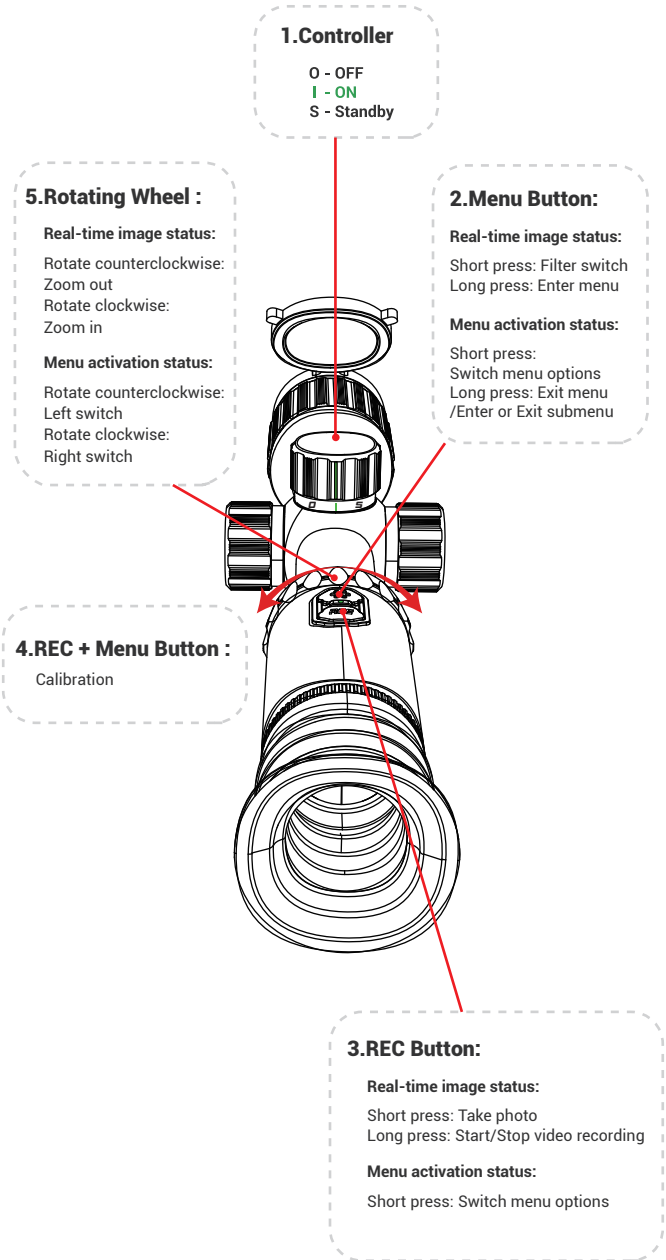

The status bar is on the top and bottom of the display and shows information on the actual operating status of the NIGHT ARROW.

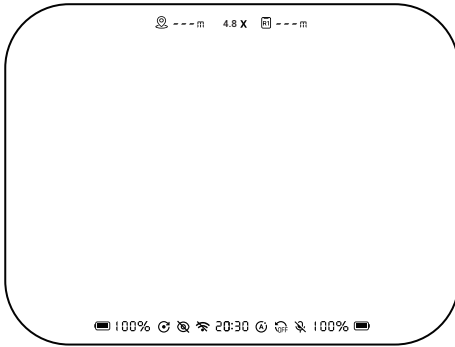

The top of the display shows information including:

- Distance
- Magnification
- Rifle Profile
- Zeroing Distance

The bottom of the display shows information including:

- External Battery Battery
- External Battery Capacity
- Recoil Video
- Display Mode
- WIFI Status
- Real Time
- Calibration Mode
- Standby Setting
- Audio
- Built-in Battery Capacity
- Built-in Battery Battery

Take photo/recording on-board

Short press REC button to take photo.

Long press REC button to start/stop video recording.

Number of photos or recording icon will be shown on the left top of the screen.

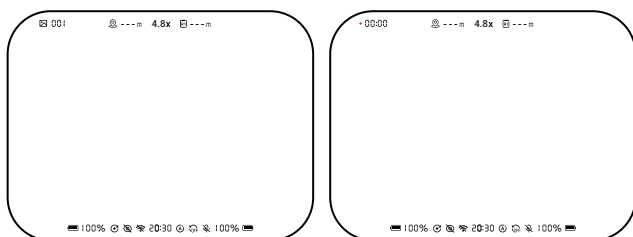

Firmware update via APP

Easily keep your device at the forefront of technology with firmware updates directly through our dedicated app.



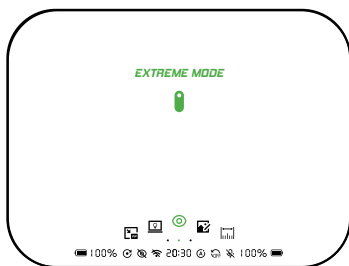



Extreme mode

Short press **MENU/REC** button to turn Extreme mode On/Off.

Image Equalizer

Short press **MENU/REC** button to select:

-  **Brightness** Rotate the wheel to change the Brightness value from 1-5
-  **Contrast** Rotate the wheel to change the Contrast value from 1-5
-  **Sharpness** Rotate the wheel to change the Sharpness value from 1-5

Rangefinder

Stadiametric rangefinder

(only in NAR 335PRO/NAR 350PRO/NAR 635PRO/NAR 650PRO)

NIGHT ARROW is equipped with a stadiametric rangefinder which allows the user to estimate approximate distance to an object of known size.

Short press **MENU/REC** button to enter Rangefinder.

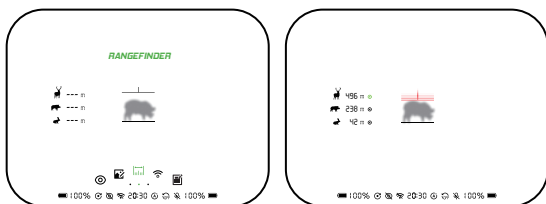

You will see on the display: measurement bars, icons of three reference objects and respective distances for the three objects.

There are three pre-set reference objects:

Rabbit – height 0.2m

Wild boar – height 0.5m

Deer – height 1.7m

Please move lower fixed bar to the bottom of the object, then rotate the wheel to move down/up of the upper line to the top of the object. The distance of the object is automatically recalculated as you move the upper line.

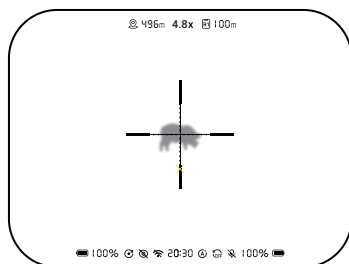

Press the **MENU/REC** button to choose reference object. Long press **MENU** to save & exit the rangefinder, the range information will not disappear from the display automatically.

A "X" on reticle suggests the aiming point accordingly.



Laser rangefinder (only available in NAR LIIR series)

Short press **MENU/REC** to enter the laser rangefinder selection, and rotate the wheel to turn on single ranging or continuous ranging. But only one can be turned on at a time.

-  Single ranging
-  Continuous ranging

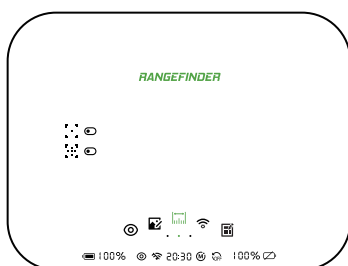

Short press **MENU** and the distance will be shown in the top left screen.

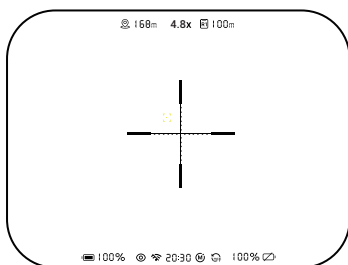

For an enhanced user experience, please first complete the zeroing process, followed by finalizing the Ballistic Calculate parameter settings.

When the continuous ranging is turned on, the relevant distance will show up. A "X" on reticle suggests the aiming point accordingly.

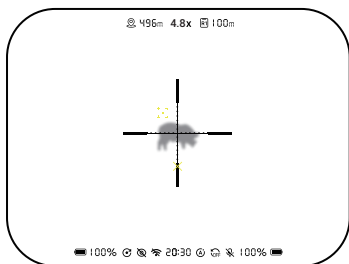

WIFI

Short press **MENU/REC** button to turn WIFI On/Off.

Ballistic Calculator

Short press **MENU** to enter Ballistic calculator. Then rotate the wheel to turn on/off the function. Short press the **MENU/REC** to select Ballistic data, Velocity, Wt, Bullet BC, Drag Model, Scope Ht, and Zero range, then rotate the wheel adjust the value matching your rifle. Long press **MENU** to save and exit.

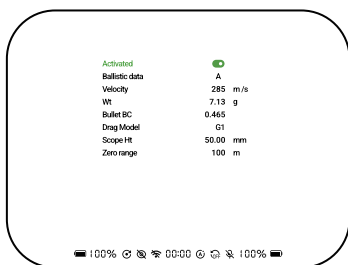

Ballistic data - Maximum storage capacity for 5 types of bullets.

Velocity, Wt, Bullet BC - On the bullet package or ask the bullet supplier.

Drag Model - G1 for short, flat-based bullets, G7 for long bullet with a boat-tail and pointy nose.

Scope Ht - The distance from the center of the weapon barrel to the center of the lens.

After entering the ballistic calculation parameters, please ensure to perform zeroing to enable precise usage.

Profile

NIGHT ARROW can maximize save 3 profiles of rifles.

Short press **MENU/REC** button to select R1, R2 or R3.

Long press **MENU/REC** button to save and exit.

Select the zeroing profile, R1 is set as default. The zeroing distance is set in Ballistic calculator.

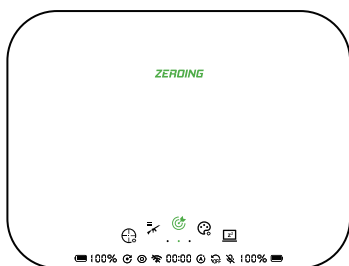

Take a shot, make the cross center of the reticle at point of impact. Short press **MENU/REC** button to switch zeroing options.

Windage/Elevation

Then rotate the wheel to adjust the X,Y value.

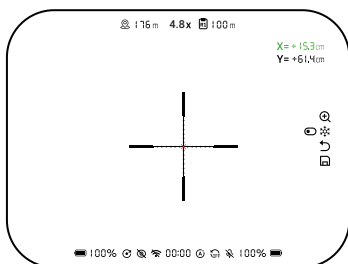

Zoom

Short press **MENU/REC** button to select zoom function, then rotate the wheel to zoom in/out the reticle.

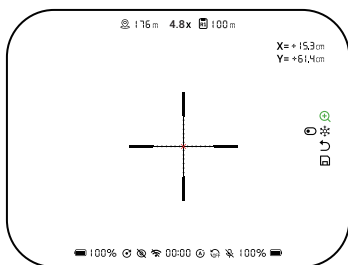

Freeze

The feature of the freeze function is that there is no need to constantly keep the riflescope at the point of aiming.

After shooting, the user needs to align the dividing center point with the center of the cross target, and then rotate the wheel to freeze the infrared image of the X value and Y value.

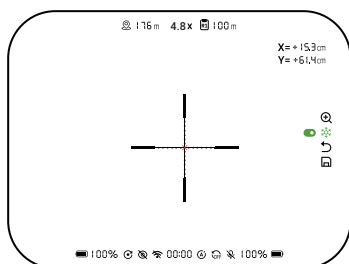

When freezing the image, you can short press **MENU/REC** button to adjust the other options in the zero calibration.

Then you can rotate the wheel to unfreeze the image. Long press **MENU/REC** to save.

Back: Long press the **MENU** button to return to the previous menu, the current settings will not be saved.

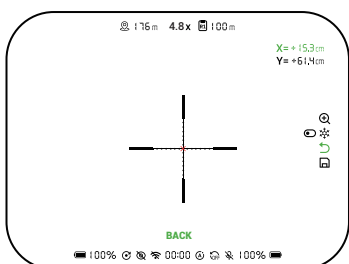

Save and exit: Long press the **MENU** button to save and exit.

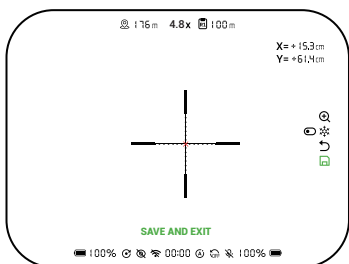

 **Brightness** Short press **MENU/REC** to enter the brightness selection, and rotate the wheel to select the value from 1-5. Long press **MENU** to save and exit.



Color

Short press **MENU/REC** button to enter the color selection, and rotate the wheel to select the desired reticle color, including Green, Red, White, and Black. Long press **MENU** button to save and exit.



Type

Short press **MENU/REC** button to enter the reticle type selection and rotate the wheel to select one from 4 reticle types. Long press **MENU** button to save and exit.

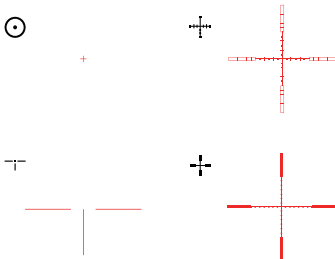

Recoil video

Short press **MENU/REC** to turn on/off the function. The pre-recording function activates upon detecting recoil, capturing a 10-second span before and after your shot.



Microphone

Short press **MENU/REC** to turn on/off the microphone.



Calibration Mode

Short press **MENU/REC** button to choose the calibration mode and long press **MENU** button to save and exit.



Automatic



Manual



Silent (Please close lens cap when calibrating)



Defective Pixel Repair

Cover objective lens then short press **MENU** button to perform defective pixel repair. A three-second countdown will appear on the screen, and the calibration will be started.



Pure Mode

Short press **MENU/REC** button to turn Pure Mode On/Off. The icons of submenu will be hidden automatically.



Color Mode

Short press **MENU/REC** button to switch through the color modes.

Rotate the wheel to select activated or deactivated current color modes.

Color Modes can be selectively deactivated. Deactivated color modes will not show up so you only cycle through modes that you find useful.

The available Color Modes are:

WH - White Hot BH – Black Hot WW – Warm White
CG – Cold Green CB – Cold Blue RB - Rainbow



Standby Setting

Short press **MENU/REC** button to switch the option

from



Advanced Settings

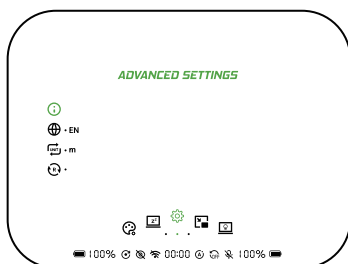

Device Info Contain Model, S/N, software version and hardware version.

Language Rotate the wheel to select from EN/DE/RU/CZ/ES/SE/PL, long press **MENU/REC** button to save and exit

Unit Rotate the wheel to select from Meter and Yard, long press **MENU/REC** button to save and exit.

Restore Rotate the wheel to select YES/NO, long press **MENU** button to save and exit.



PIP

Short press **MENU/REC** button to turn PIP On/Off.



Screen Brightness

Press **MENU/REC** button to enter and rotate the wheel to change the value from 1-5, long press **MENU** button to save and exit.

Removable battery

The batteries should be charged before first use.
Turn the battery compartment knob counterclockwise until stop.

Please install the battery based on the positive and negative signs.
Otherwise, NIGHT ARROW will not start.

Replace the battery and close the compartment knob.

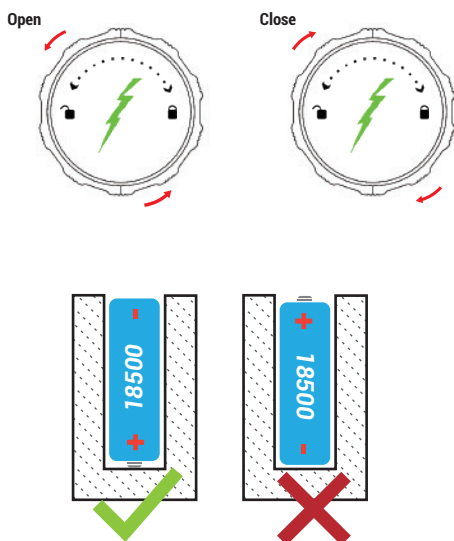

Built-in battery

NIGHT ARROW is powered by built-in rechargeable battery of total 6400 mAh and 1 removable 18500 battery.

- 1.If there are built-in battery and removable battery in the device, two battery icons are displayed in the status bar. The removable battery capacity shows on the left bottom of the status bar, and the built-in battery capacity shows on the right bottom.
- 2.When both type of batteries are fully charged, the device is powered by the removable battery. If there is low removable battery level, the device will switch to the built-in battery.
- 3.Battery charge status is displayed on the status bar.

	100%	90%	80%	70%	60%	50%	40%	30%	20%	10%	No battery	Charging
Removable Battery Capacity												
Built-in Battery Capacity												

- 4.It is possible to replace removable battery while NIGHT ARROW is on when it is powered by built-in battery (the device will continue to work properly).

External power supply

External power can be supplied from an external source, such as a power bank.

1. Connect the external power supply to the USB-C cable.
2. NIGHT ARROW takes to external power source while the built-in battery will gradually be recharged.
3. A rechargeable battery icon indicating a percentage of the battery life will appear in the status bar .
4. NIGHT ARROW supports quick fully charge in only 3 hours.
5. When you turn off external power source, NIGHT ARROW takes power from removable battery without turning off. When there is no removable battery or low power level the device takes power from the built-in battery.

NOTE

The batteries should be charged before first us.

When installing a removable battery with a sufficient charge level, NIGHT ARROW will automatically switch to it.

Zeroing information will be saved when NIGHT ARROW is shut down because of empty battery.

If NIGHT ARROW is shut down by opening battery cover without proper power off, zeroing information will not be saved.

Cable connection

1. Power supply/Firmware update/Charge built-in battery

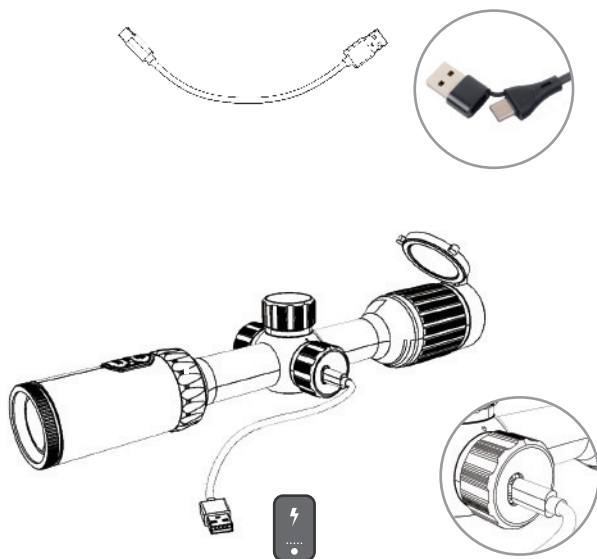

Attach to rifle

To ensure accurate shooting NIGHT ARROW should be properly mounted on the rifle.

Mount NIGHT ARROW with 30mm scope rings. Use only high-quality mounts and rings compatible with your rifle. Follow the mount manufacturer's installation instructions and use the proper tools.

When mounting NIGHT ARROW, adjust the position of the scope on the rifle to achieve optimal, comfortable eye relief. Failure to comply with this recommendation may result in injury to the shooter.

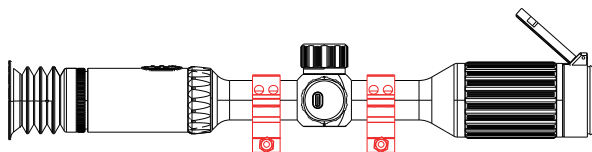

- Before storing it, clean obligatory the device.
(In case of moisture, dust or traces of dirt on its surface)
- Make sure that there are no traces of moisture, and the battery compartment is empty!
- It is also possible for a short period of time device to be stored in a suitable soft pack, bag or cartridge box.
- The premises in which the device is kept for long term have to be dry, enclosed, unheated and ventilated.
- During the storage should not be allowed exposure to aggressive environments, temperatures below -50°C and above $+60^{\circ}\text{C}$, relative humidity greater than 80%, and prolonged periods of direct sunlight.
- Before each transportation, the product should be neatly packed in its original packaging (transport bag) and all other items and accessories should be carefully and steadily placed in the bag.
- You can ship the product with all types of transport at different distances and at altitude up to 12000m.

Night Arrow Specification

Model	NAR 335PRO	NAR 350PRO	NAR 350LIIR	NAR 635PRO	NAR 650PRO	NAR 650LIIR
Main Characteristics						
Detector	Uncooled Vox					
Resolution	384×288			640×512		
Frame rate	50Hz					
Pixel	12μm					
Spectral range	8-14μm					
NETD	<20mk					
Optical Characteristics						
Objective lens	35mm	50mm	50mm	35mm	50mm	50mm
Magnification	3.3x	4.8x	4.8x	1.9x	2.7x	2.7x
FOV(HxV), m@100m	13.2×10	9.2×7	9.2×7	22×18	15.4×12.3	15.4×12.3
Close-up range	3m					
Dioptr adjustment	±5D					
Detection Range						
Detection distance (Target size: 1.7m×0.5m, P(n)=99%)	2480m	3540m	3540m	2480m	3540m	3540m
Functions						
Zoom	1x/1.5x/2x/2.5x/3x/4x/5x/6x					
Palettes	6					
Firmware update via APP	Yes					
Display						
Type	OLED					
Resolution	1024×768					
External video	WIFI					
Built-in memory	32GB					
Power Supply						
Battery	2×18650 (Built-in battery) + 1×18500 (External battery)					
External power supply	5V-2A, 9V-2A (USB Type-C)					
Operating time (at t=22°C)	12h					
Physical Characteristics						
Weight (without external battery)	900g	950g	990g	900g	950g	990g
Dimension	72×89×375mm	72×89×390mm	72×89×380mm	72×89×375mm	72×89×390mm	72×89×380mm
Environmental Compatibility						
Ingress protection rating	IP67					
Operating temperature	-20°C -50°C					
Storage temperature	-40°C -60°C					
Shock resistance	1200g,1ms					
Laser Rangefinder (Only available in NAR 650LIIR)						
Safety class for laser equipment according to IEC 60825-1:2014	/		1	/		1
Measuring range	/		5-1200m	/		5-1200m
Measurement accuracy	/		± 1m	/		± 1m



Wuhan CONO Technology Co., Ltd
Tel:0086-27-86635300
Email: Support@cono-tech.com
www.cono-tech.com